

Article number: 201059027

Description: E+G Indexing plunger  
GN 607.4-8-8-ST

## Measures

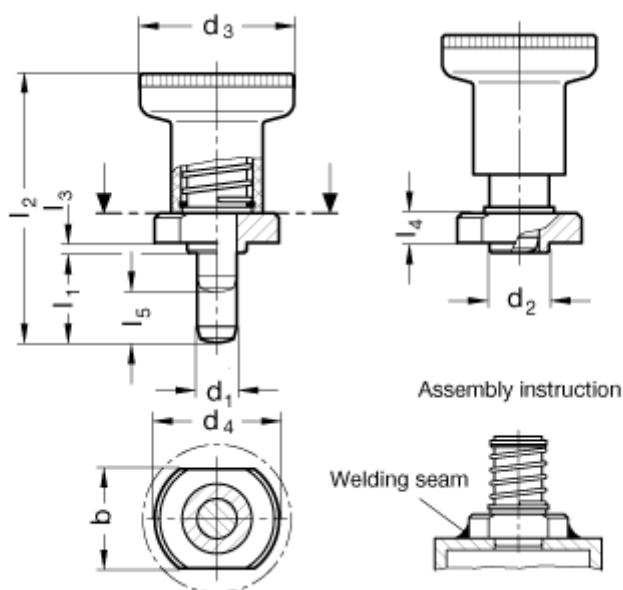

$b = 20$	$l_4 = 6,5$
$d_1 = 8$	$l_5 = 8$
$d_2 = 12$	Max. axial load (N) = 500
$d_3 = 31$	Spring pressure end (N) = 28
$d_4 = 25$	Spring pressure preload (N) = 15,5
$l_1 = 8$	
$l_2 = 44/54$	
$l_3 = 2$	